

CP933 - Gigabit Ethernet Switch with Integrated NIC

Doc. Rev.1.0

Doc. ID: 1061-9948

This page has been intentionally left blank



CP933 - GIGABIT ETHERNET SWITCH WITH INTEGRATED NIC - USER GUIDE

Disclaimer

Kontron would like to point out that the information contained in this user guide may be subject to alteration, particularly as a result of the constant upgrading of Kontron products. This document does not entail any guarantee on the part of Kontron with respect to technical processes described in the user guide or any product characteristics set out in the user guide. Kontron assumes no responsibility or liability for the use of the described product(s), conveys no license or title under any patent, copyright or mask work rights to these products and makes no representations or warranties that these products are free from patent, copyright or mask work right infringement unless otherwise specified. Applications that are described in this user guide are for illustration purposes only. Kontron makes no representation or warranty that such application will be suitable for the specified use without further testing or modification. Kontron expressly informs the user that this user guide only contains a general description of processes and instructions which may not be applicable in every individual case. In cases of doubt, please contact Kontron.

This user guide is protected by copyright. All rights are reserved by Kontron. No part of this document may be reproduced, transmitted, transcribed, stored in a retrieval system, or translated into any language or computer language, in any form or by any means (electronic, mechanical, photocopying, recording, or otherwise), without the express written permission of Kontron. Kontron points out that the information contained in this user guide is constantly being updated in line with the technical alterations and improvements made by Kontron to the products and thus this user guide only reflects the technical status of the products by Kontron at the time of publishing.

Brand and product names are trademarks or registered trademarks of their respective owners.

©2018 by Kontron S&T AG

Kontron S&T AG

Lise-Meitner-Str. 3-5
86156 Augsburg
Germany
www.kontron.com

High Risk Applications Hazard Notice

THIS DEVICE AND ASSOCIATED SOFTWARE ARE NOT DESIGNED, MANUFACTURED OR INTENDED FOR USE OR RESALE FOR THE OPERATION OF NUCLEAR FACILITIES, THE NAVIGATION, CONTROL OR COMMUNICATION SYSTEMS FOR AIRCRAFT OR OTHER TRANSPORTATION, AIR TRAFFIC CONTROL, LIFE SUPPORT OR LIFE SUSTAINING APPLICATIONS, WEAPONS SYSTEMS, OR ANY OTHER APPLICATION IN A HAZARDOUS ENVIRONMENT, OR REQUIRING FAIL-SAFE PERFORMANCE, OR IN WHICH THE FAILURE OF PRODUCTS COULD LEAD DIRECTLY TO DEATH, PERSONAL INJURY, OR SEVERE PHYSICAL OR ENVIRONMENTAL DAMAGE (COLLECTIVELY, "HIGH RISK APPLICATIONS").

You understand and agree that your use of Kontron devices as a component in High Risk Applications is entirely at your risk. To minimize the risks associated with your products and applications, you should provide adequate design and operating safeguards. You are solely responsible for compliance with all legal, regulatory, safety, and security related requirements concerning your products. You are responsible to ensure that your systems (and any Kontron hardware or software components incorporated in your systems) meet all applicable requirements. Unless otherwise stated in the product documentation, the Kontron device is not provided with error-tolerance capabilities and cannot therefore be deemed as being engineered, manufactured or setup to be compliant for implementation or for resale as device in High Risk Applications. All application and safety related information in this document (including application descriptions, suggested safety measures, suggested Kontron products, and other materials) is provided for reference only.

Revision History

Revision	Brief Description of Changes	Date of Issue
1.0	Initial version	2018-Aug 17

Terms and Conditions

Kontron warrants products in accordance with defined regional warranty periods. For more information about warranty compliance and conformity, and the warranty period in your region, visit <http://www.kontron.com/terms-and-conditions>.

Kontron sells products worldwide and declares regional General Terms & Conditions of Sale, and Purchase Order Terms & Conditions. Visit <http://www.kontron.com/terms-and-conditions>.

For contact information, refer to the corporate offices contact information on the last page of this user guide or visit our website [CONTACT US](#).

Customer Support

Find Kontron contacts by visiting: <http://www.kontron.com/support>.

Customer Service

As a trusted technology innovator and global solutions provider, Kontron extends its embedded market strengths into a services portfolio allowing companies to break the barriers of traditional product lifecycles. Proven product expertise coupled with collaborative and highly-experienced support enables Kontron to provide exceptional peace of mind to build and maintain successful products.

For more details on Kontron's service offerings such as: enhanced repair services, extended warranty, Kontron training academy, and more visit <http://www.kontron.com/support-and-services/services>.

Customer Comments

If you have any difficulties using this user guide, discover an error, or just want to provide some feedback, contact [Kontron support](#). Detail any errors you find. We will correct the errors or problems as soon as possible and post the revised user guide on our website.

Symbols

The following symbols may be used in this user guide

⚠ DANGER

DANGER indicates a hazardous situation which, if not avoided, will result in death or serious injury.

⚠ WARNING

WARNING indicates a hazardous situation which, if not avoided, could result in death or serious injury.

NOTICE

NOTICE indicates a property damage message.

⚠ CAUTION

CAUTION indicates a hazardous situation which, if not avoided, may result in minor or moderate injury.



Electric Shock!

This symbol and title warn of hazards due to electrical shocks (> 60 V) when touching products or parts of products. Failure to observe the precautions indicated and/or prescribed by the law may endanger your life/health and/or result in damage to your material.



ESD Sensitive Device!

This symbol and title inform that the electronic boards and their components are sensitive to static electricity. Care must therefore be taken during all handling operations and inspections of this product in order to ensure product integrity at all times.



HOT Surface!

Do NOT touch! Allow to cool before servicing.



Laser!

This symbol inform of the risk of exposure to laser beam and light emitting devices (LEDs) from an electrical device. Eye protection per manufacturer notice shall review before servicing.



This symbol indicates general information about the product and the user guide.

This symbol also indicates detail information about the specific product configuration.



This symbol precedes helpful hints and tips for daily use.

For Your Safety

Your new Kontron product was developed and tested carefully to provide all features necessary to ensure its compliance with electrical safety requirements. It was also designed for a long fault-free life. However, the life expectancy of your product can be drastically reduced by improper treatment during unpacking and installation. Therefore, in the interest of your own safety and of the correct operation of your new Kontron product, you are requested to conform with the following guidelines.

High Voltage Safety Instructions

As a precaution and in case of danger, the power connector must be easily accessible. The power connector is the product's main disconnect device.

CAUTION

Warning

All operations on this product must be carried out by sufficiently skilled personnel only.

CAUTION



Electric Shock!

Before installing a non hot-swappable Kontron product into a system always ensure that your mains power is switched off. This also applies to the installation of piggybacks. Serious electrical shock hazards can exist during all installation, repair, and maintenance operations on this product. Therefore, always unplug the power cable and any other cables which provide external voltages before performing any work on this product.

Earth ground connection to vehicle's chassis or a central grounding point shall remain connected. The earth ground cable shall be the last cable to be disconnected or the first cable to be connected when performing installation or removal procedures on this product.

Special Handling and Unpacking Instruction

NOTICE



ESD Sensitive Device!

Electronic boards and their components are sensitive to static electricity. Therefore, care must be taken during all handling operations and inspections of this product, in order to ensure product integrity at all times.

Do not handle this product out of its protective enclosure while it is not used for operational purposes unless it is otherwise protected.

Whenever possible, unpack or pack this product only at EOS/ESD safe work stations. Where a safe work station is not guaranteed, it is important for the user to be electrically discharged before touching the product with his/her hands or tools. This is most easily done by touching a metal part of your system housing.

It is particularly important to observe standard anti-static precautions when changing piggybacks, ROM devices, jumper settings etc. If the product contains batteries for RTC or memory backup, ensure that the product is not placed on conductive surfaces, including anti-static plastics or sponges. They can cause short circuits and damage the batteries or conductive circuits on the product.

Lithium Battery Precautions

If your product is equipped with a lithium battery, take the following precautions when replacing the battery.

CAUTION

Danger of explosion if the battery is replaced incorrectly.

- ▶ Replace only with same or equivalent battery type recommended by the manufacturer.
- ▶ Dispose of used batteries according to the manufacturer's instructions.

General Instructions on Usage

In order to maintain Kontron's product warranty, this product must not be altered or modified in any way. Changes or modifications to the product, that are not explicitly approved by Kontron and described in this user guide or received from Kontron Support as a special handling instruction, will void your warranty.

This product should only be installed in or connected to systems that fulfill all necessary technical and specific environmental requirements. This also applies to the operational temperature range of the specific board version that must not be exceeded. If batteries are present, their temperature restrictions must be taken into account.

In performing all necessary installation and application operations, only follow the instructions supplied by the present user guide.

Keep all the original packaging material for future storage or warranty shipments. If it is necessary to store or ship the product then re-pack it in the same manner as it was delivered.

Special care is necessary when handling or unpacking the product. See Special Handling and Unpacking Instruction.

Quality and Environmental Management

Kontron aims to deliver reliable high-end products designed and built for quality, and aims to complying with environmental laws, regulations, and other environmentally oriented requirements. For more information regarding Kontron's quality and environmental responsibilities, visit <http://www.kontron.com/about-kontron/corporate-responsibility/quality-management>.

Disposal and Recycling

Kontron's products are manufactured to satisfy environmental protection requirements where possible. Many of the components used are capable of being recycled. Final disposal of this product after its service life must be accomplished in accordance with applicable country, state, or local laws or regulations.

WEEE Compliance

The Waste Electrical and Electronic Equipment (WEEE) Directive aims to:

- ▶ Reduce waste arising from electrical and electronic equipment (EEE)
- ▶ Make producers of EEE responsible for the environmental impact of their products, especially when the product become waste
- ▶ Encourage separate collection and subsequent treatment, reuse, recovery, recycling and sound environmental disposal of EEE
- ▶ Improve the environmental performance of all those involved during the lifecycle of EEE



Environmental protection is a high priority with Kontron.

Kontron follows the WEEE directive

You are encouraged to return our products for proper disposal.

Table of Contents

Symbols	6
For Your Safety	7
High Voltage Safety Instructions	7
Special Handling and Unpacking Instruction	7
Lithium Battery Precautions.....	8
General Instructions on Usage	8
Quality and Environmental Management	8
Disposal and Recycling.....	8
WEEE Compliance.....	8
Table of Contents	9
List of Tables	10
List of Figures	10
1/ Introduction	11
1.1. System Overview	11
1.2. Board Overview.....	11
1.2.1. System Level Interfacing	11
1.3. Board Variants.....	12
1.4. Board Diagrams.....	12
1.4.1. Functional Block Diagram.....	12
1.4.2. Front Panel Connectors.....	13
1.4.3. Board Layout.....	14
1.5. Technical Specification.....	16
1.6. Environmental Considerations	18
1.6.1. Environmental Specification.....	18
1.6.2. Thermal Management	18
1.7. Standards.....	19
1.8. Related Publications	19
2/ Functional Description	20
2.1. General Information.....	20
2.2. Gigabit Ethernet Switch Controller.....	20
2.3. Gigabit Ethernet Controller (Integrated NIC).....	21
2.4. PCI to PCI Express Bridge	21
2.5. Ethernet Transformers (Magnetics).....	21
2.6. Front Panel Status LEDs.....	21
2.7. On-board Status LEDs.....	22
2.8. Board Interfaces.....	23
2.8.1. Front Panel Ethernet Interfaces	23
2.8.2. CompactPCI Connector (J1) Interface	24
3/ Installation	26
3.1. Hardware Installation.....	26
3.1.1. Safety Requirements.....	26
3.1.2. Location on the Backplane.....	26
3.1.3. Hot Swap Capabilities.....	26
3.1.4. Board Installation Procedures	27
3.1.5. Board Removal Procedures.....	27
3.1.6. Cabling.....	28

3.2. Software Installation	28
4/ Configuration.....	29
5/ Power Considerations	30
5.1. System Power.....	30
5.2. Voltage Requirements	30
5.3. Backplane Requirements	30
5.4. Power Consumption.....	30
6/ Support.....	31
6.1. Product Identification and Type Label	31
7/ Warranty.....	32
7.1. Limitation/Exemption from Warranty Obligation.....	32
8/ Returning a Defective Product.....	33
9/ Storage, Transportation, and Maintenance	34
9.1. Storage	34
9.2. Transportation	34
9.3. Maintenance	34
9.3.1. Preventative Maintenance.....	34
10/ Disposal.....	35
Appendix A: List of Acronyms.....	36
About Kontron	37

List of Tables

Table 1: CP933 Board Variants with Description.....	12
Table 2: Connector and Component Description – Top View	14
Table 3: Connector and Component Description – Bottom View	15
Table 4: Technical Specification	16
Table 5: Temperature Specification	18
Table 6: Environmental Aspects.....	18
Table 7: Thermal Aspects	18
Table 8: Applied Standards.....	19
Table 9: Related Publications	19
Table 10: Front Panel RJ45 Connectors (J6 & J7) Pin Assignment for MDI/MDIX Standards	23
Table 11: CompactPCI Connector (J1).....	24
Table 12: CompactPCI Connector (J1) Signal Description.....	25
Table 13: Supply Voltage Specification.....	30
Table 14: List of Acronyms	36

List of Figures

Figure 1: Functional Block Diagram	12
Figure 2: Front Panel Connectors.....	13
Figure 3: Board Layout – Top View.....	14
Figure 4: Board Layout – Bottom View	15
Figure 5: Front Panel LED Activity.....	22
Figure 6: On-board status LEDs	22
Figure 7: Gigabit Ethernet Connectors J6 and J7.....	23
Figure 8: Type Label.....	31

1/ Introduction

1.1. System Overview

This user guide focuses on describing the special features of the CP933 Gigabit Ethernet switch CompactPCI board denoted as CP933 within this user guide.

The CompactPCI board described in this user guide operates with the PCI bus architecture to support additional I/O and memory-mapped devices, as required by various industrial applications. The CompactPCI standard is electrically identical to the PCI local bus, for detailed information concerning the CompactPCI standard, please refer to the Peripheral Component Interconnect (PCI) specification, CompactPCI Specification, or visit the [PCI Industrial Computer Manufacturers Group \(PICMG\) CompactPCI® home page](#).

Before installing the CP933 in a CompactPCI system, Kontron recommends that new users study the installation instructions within this user guide.

For the latest revision of this user guide, datasheet or Board Support Packages (BSPs), visit Kontron's home page <http://www.kontron.com/>.

1.2. Board Overview

The CP933 is a six port, unmanaged, layer 2, Gigabit Ethernet switch with integrated NIC designed on a 3U form factor CompactPCI board for use in CompactPCI systems using the CompactPCI bus architecture.

The CP933 is part of a comprehensive concept to provide CompactPCI system integrators with a complete range of CompactPCI communications products for data networks. The CP933 ensures a maximum degree of system design flexibility, thus allowing efficient and effective use of available resources. Additionally, the CP933's design supports plug and play operation in industrial environments where the CP933's robust design is well suited for deployment in harsh environments.

The CP933 supports 10/100/1000Base-T Ethernet on five external Ethernet ports with RJ45 connectors each including two integrated status LEDs. The sixth port connects to the Gigabit Ethernet controller and acts as an integrated NIC by connecting to the master CPU over the CompactPCI system.

The CP933 can also act as independent five-port switch without any connection over CompactPCI to the master CPU. In this case, the CompactPCI architecture is used only as a power supply.

The main CP933 features are:

- ▶ Robust 3U CompactPCI board
- ▶ Plug and play, unmanaged layer 2 board
- ▶ Six Gigabit Ethernet ports
 - ▶ 5x RJ45 Ethernet connectors with full 10/100/1000Base-T support
 - ▶ 1x Gigabit Ethernet NIC to the master CPU in the CompactPCI system
- ▶ Acts as independent five port switch when NIC is not needed (power from CompactPCI backplane)
- ▶ Auto-negotiation, all ports uplink capable
- ▶ Five front panel RJ45 connectors each with two status LEDs (for link/activity and speed)
- ▶ Magnetics for equipment isolation in accordance with the IEEE 802.3 standard
- ▶ Support for Windows®, Linux® and VX Works®
- ▶ Enhanced operation for industrial/harsh environments

1.2.1. System Level Interfacing

For integration into a CompactPCI system, the CP933 is equipped with a CompactPCI connector used both for PCI Interfacing and as a power supply source.

1.3. Board Variants

The CP933 is available in different temperature grades to enable operation in standard and industrial/harsh environments.

Table 1: CP933 Board Variants with Description

Product Name	Description
CP933	6-port Gigabit Ethernet switch with 5x RJ45 on the front panel and one integrated NIC
CP933-E2	6-port Gigabit Ethernet switch with 5x RJ45 on the front panel and one integrated NIC, Extended temperature range (-40°C to +85°C)

1.4. Board Diagrams

The following figures provide additional information concerning board functionality and component layout.

1.4.1. Functional Block Diagram

Figure 1: Functional Block Diagram

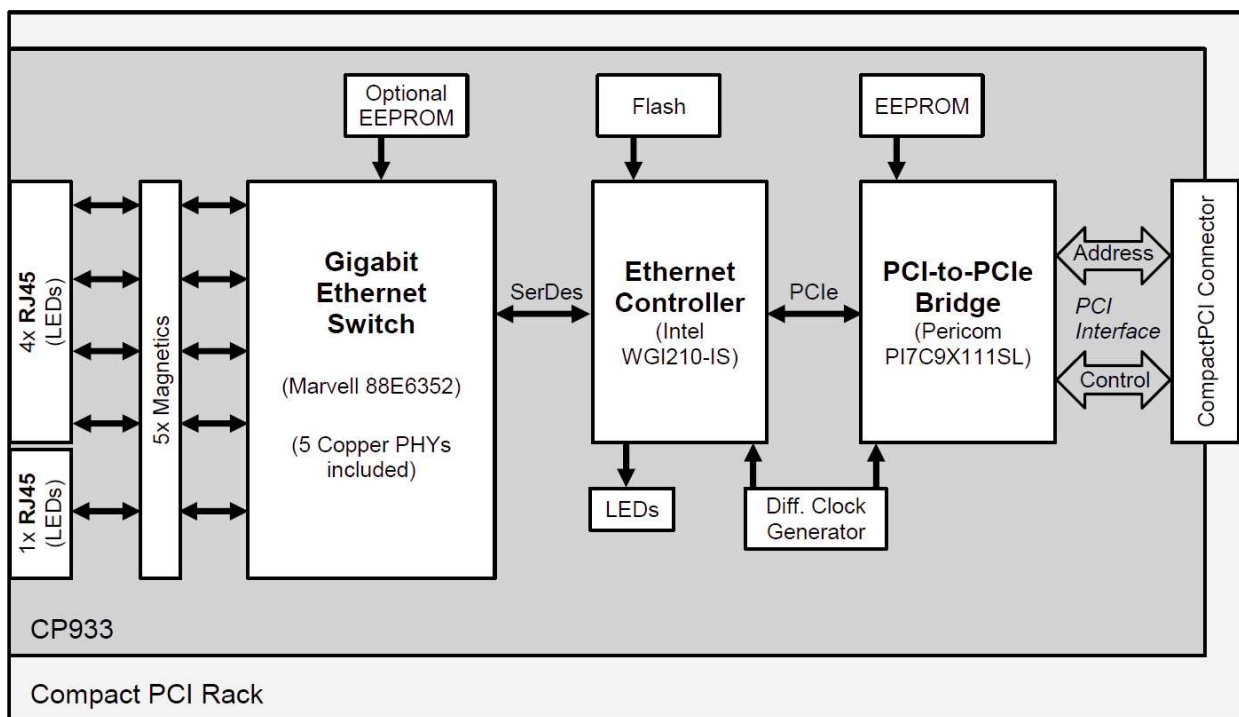

1.4.2. Front Panel Connectors

The CP933's front panel contains five RJ45 connectors, each including two integrated status LEDs (yellow/green) displaying the link/activity and speed of Ethernet ports [1-5].

Figure 2: Front Panel Connectors

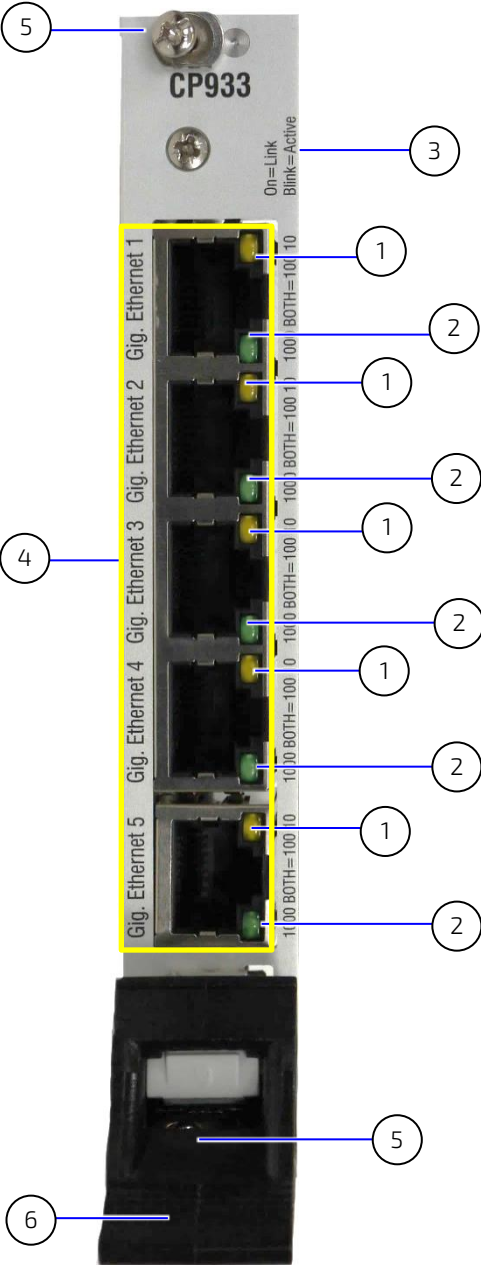

- 1. LED 1
- 2. LED 2
- 3. Short LED status activity definition
- 4. RJ45 connectors with Ethernet port label
- 5. Front panel fastening screws
- 6. Insertion and extraction handle

1.4.3. Board Layout

Figure 3: Board Layout – Top View

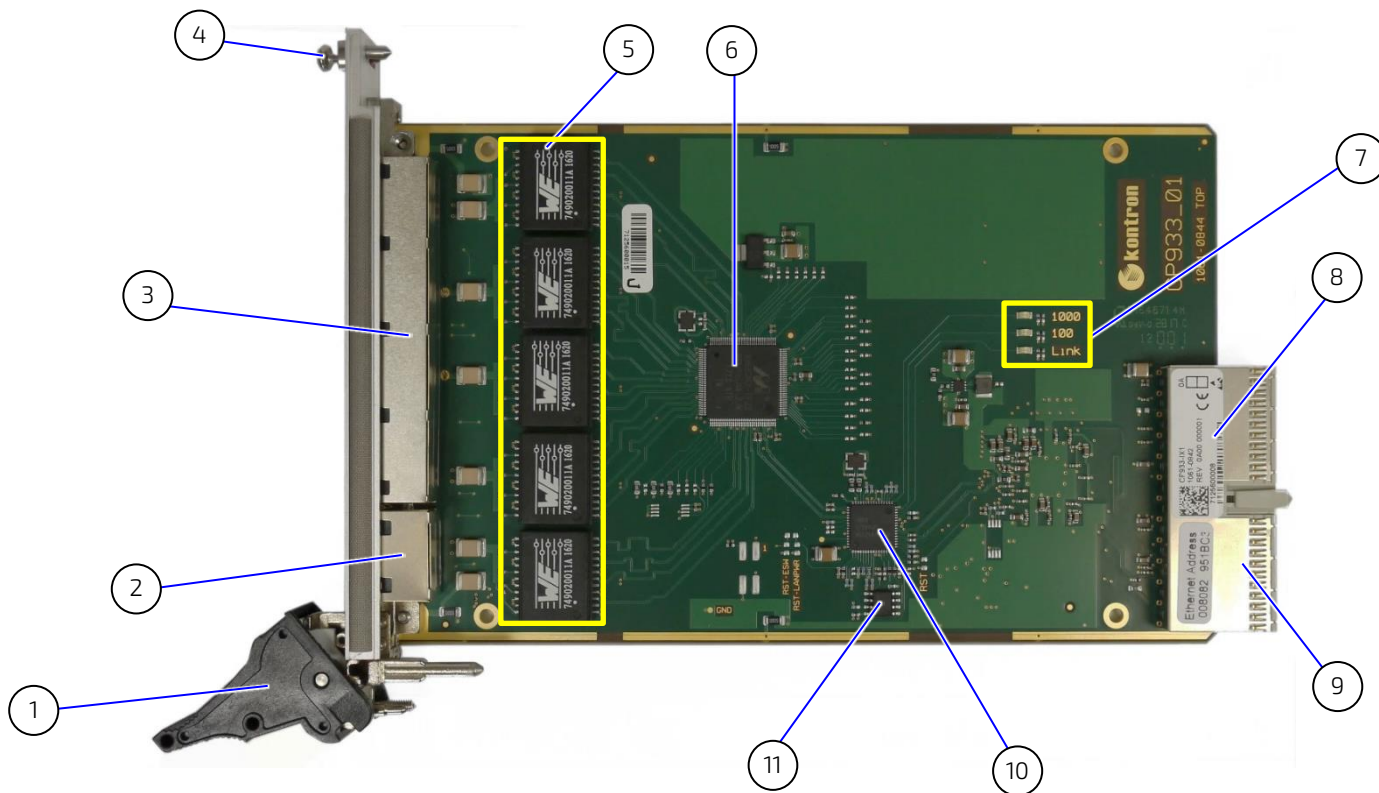

Table 2: Connector and Component Description – Top View

Item	Component	Chapter
1	Insertion and extraction handle	3.1.4 & 3.1.5
2	RJ45 connector for Ethernet port 5 with 2 indication status LEDs (J7)	2.6
3	RJ45 connector for Ethernet port [1-4] with 2 indication status LEDs (J6)	2.6
4	Top fastening screw, to securely fasten board to CompactPCI system's housing	3.1.4 & 3.1.5
5	Ethernet transformer (Magnetics)	2.5
6	Ethernet switch controller	2.2
7	On-board status LEDs for NIC 1000 - ON for established 1000Mbit/s 100 - ON for established 100Mbit/s [1] Link - ON to display Link/activity	2.7
8	Type label Including product name, product number and serial number	6.1
9	32-bit, female CompactPCI connector (J1)	2.8.2
10	Ethernet controller	2.3
11	Flash memory	

[1] The status LED 100 is for test purposes only. In operation, the SERDES interface connects to the Ethernet controller using 1000 Mbit/s only and the 100 Mbit/s LED does not light up.

Figure 4: Board Layout – Bottom View

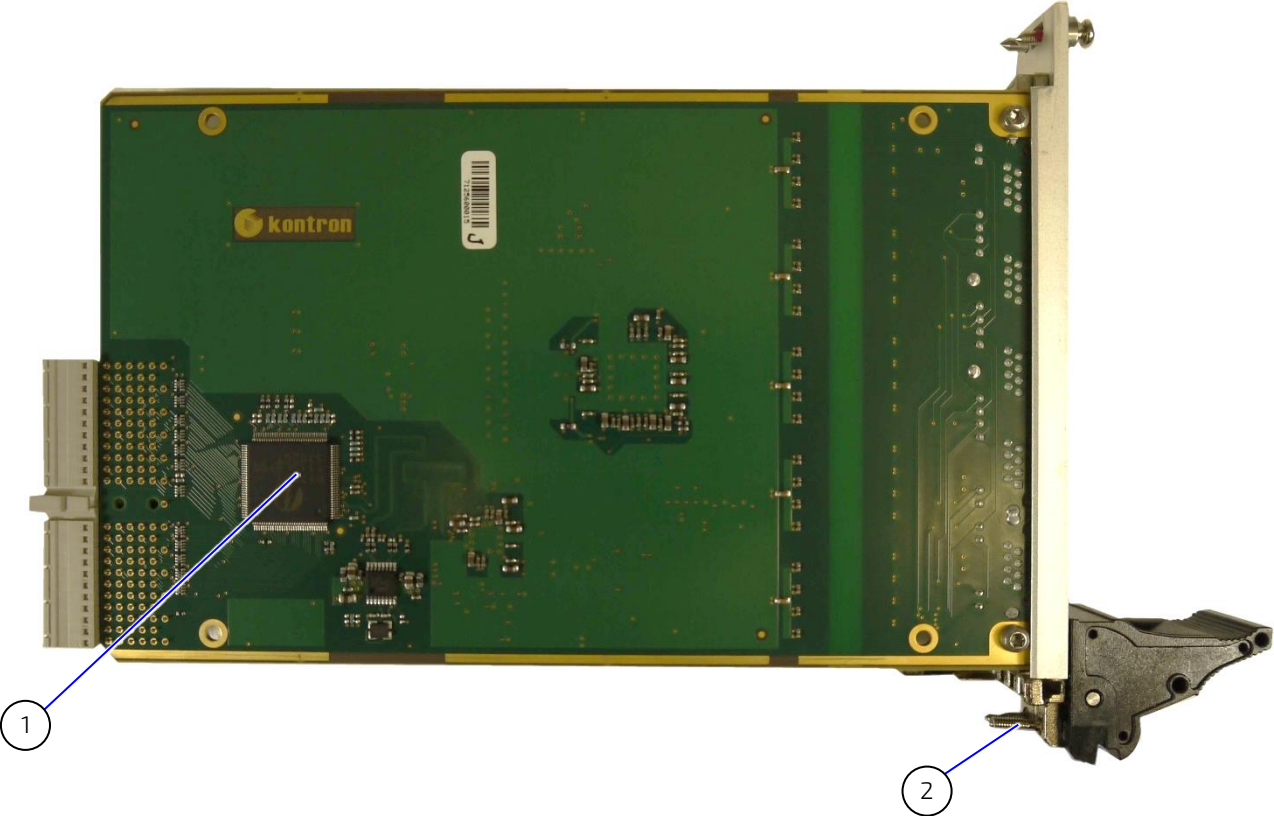



Table 3: Connector and Component Description – Bottom View



Item	Component	Chapter
1	PCI to PCIe bridge	2.4
2	Bottom fastening screw, to securely fasten board to CompactPCI system's housing	3.1.4 & 3.1.5

1.5. Technical Specification

The following table provides information regarding the CP933's main technical specifications.

Table 4: Technical Specification

Form Factor	
CPCI Form Factor	3U/4HP CompactPCI board
Dimensions	100 mm x 160 mm, single-height
Weight	146g
Controller	
Ethernet Switch Controller	Marvell 88E6352, Ethernet switch controller uses six Ethernet ports where five ports are equipped with 10/100/1000Base-T Ethernet transceivers (copper PHYs) and the sixth port utilizes a SERDES interface to connect to the NIC.
Ethernet Controller	Intel I210-IS Gigabit Ethernet controller acts as an integrated NIC connecting the CompactPCI interface with the Ethernet switch controller's SERDES port.
PCI to PCIe bridge	Pericom PI7C9X111SL PCI to PCIe bridge used in reverse mode, translates the Ethernet controller's PCIe signal to a PCI signal, as required by the CompactPCI backplane.
Internal Interfaces	
PCI Bus	32-bit, PCI bus compliant with the CompactPCI Spec. V. 2.0, Rev. 3.0 Universal signaling: 3.3 V V(I/O) with 5 V V(I/O) tolerance PCI clock: 33 MHz or 66 MHz
On-board LEDs	3x on-board LEDs: Display network status of the sixth Ethernet port 1000 Mbit/s, 100 Mbit/s and Ethernet activity
	 <p>The status LED 100 is for test purposes only. In operation, the SERDES interface connects to the Ethernet controller using 1000 Mbit/s only and the 100 Mbit/s LED does not light up.</p>
Front Panel Interface	
Front Panel Connectors	5x RJ45 connectors (8-pin, female)
Front Panel LEDs	2x Status LEDs (green/yellow) integrated in each front panel RJ45 connector to indicate the Ethernet port's operational status.
On-Board Connector	
CPCI	1x 2 mm x 2 mm pitch, 110-pin, female, CompactPCI connector (J1), at the rear of the board with support for 32-bit PCI bus signals, arbitration, 33 MHz or 66MHz clock and power.
General	
Jumpers	Plug and play board. No jumpers must be set

Power Considerations	
Power Requirements	<p>Powered by the CompactPCI backplane with: 3.3 V: 3.3 V +5% /-3% V(I/O): 5 V or 3.3 V +5% /-3%</p> <hr/>  <p>To power up, the board must be connected to the CompactPCI backplane.</p> <hr/>
Power Considerations - continued	
Power Consumption	<p>Maximum calculated power 4.5 W</p> <hr/>  <p>This value is a calculated typical theoretical maximum and has not been tested.</p> <hr/>
Software	
Operating Systems (OS)	<p>Windows® 10, Windows® 7, Windows® Embedded standard 7 Linux® VxWorks® 6.9, 7 (Other OSs may be possible, for more information contact Kontron Support.)</p>

1.6. Environmental Considerations

1.6.1. Environmental Specification

Kontron defines the following operating and non-operating (storage) temperature ranges. In a passively cooled system the ambient temperature, where ambient is the temperature surrounding the CompactPCI rack, must be considered when placing the board in a CompactPCI backplane slot within the CompactPCI system rack.

NOTICE

The difference between the ambient temperature surrounding the CompactPCI rack and the operating temperature on the PCB inside the system must be considered.

Table 5: Temperature Specification

Standard Temperature Range	
Operating Temperature (forced air cooled)	0°C to +60°C
Ambient Temperature (surrounding CompactPCI Rack)	Might be +48°C in a passive cooled system
Storage Temperature	-55°C to +125°C
Extended Temperature Range	
Operating Temperature (forced air cooled)	-40°C to +85°C
Ambient Temperature (surrounding CompactPCI Rack)	Might be +63°C in a passive cooled system
Storage Temperature	-55°C to +125°C

Table 6: Environmental Aspects

Environmental Aspects	
Humidity	93 % RH non-condensing
Operating Altitude	Up to 2000 m maximum

1.6.2. Thermal Management

The CP933 is designed to efficiently support forced airflow concepts as found in a modern CompactPCI rack supporting vertical card orientation for improved cooling. The CP933's physical size, shape, and construction ensures the best possible thermal resistance (Rth) coefficients.

NOTICE

Forced air-cooling is a requirement and must be considered in the system.

Table 7: Thermal Aspects

Thermal Aspects	
Forced Airflow	For proper operation at the specified temperatures, the CP933 requires a minimum airflow of 1 m/s.

NOTICE

When used in a dust-prone environment, an air filter must be considered within CompactPCI rack. For more information, see Chapter 9.3: Maintenance.

1.7. Standards

The CP933 is CE compliant and been found to comply with the following standards and directives.

Table 8: Applied Standards

	Type	Standard	
CE	Emission	EN 55032 Class B	
	Immission	EN 61000-6-2	
	Safety	IEC 61010-1	
Environment and Health Aspects	Shock	IEC 60068-2-27	Half sine. 9 ms, 30 g
	Bump	IEC 60068-2-29	Half sine. 11 ms, 15 g
	Vibration	IEC 60068-2-6	Sinusoidal, 10 Hz – 150 Hz, 5 g
	UL	Designed to meet UL / CSA 60950-1	
	MTBF	System MTBF (hour) = 490190 @ 40°C for the CP933	
	WEEE	Complies with the Waste Electrical and Electronic Equipment (WEEE) Directive 2012/19/EC	
	RoHS II	Complies with the Restriction of use of Hazardous Substances in electrical and electronic equipment RoSH II Directive 2011/65/EC	

1.8. Related Publications

Table 9: Related Publications

Product	Publication
CP933	PICMG CompactPCI® Overview

2/ Functional Description

The following chapter presents more detailed CP933 Gigabit Ethernet switch, board level information whereby the board components and their basic functionality are discussed in general.

2.1. General Information

The CP933 is a six port, unmanaged, layer 2, Gigabit Ethernet switch with integrated NIC designed on a 3U form factor CompactPCI board for use in CompactPCI systems using the CompactPCI bus architecture.

The CP933 comprising of the following main functional components:

- ▶ Gigabit Ethernet Switch Controller
 - ▶ Five 10/100/1000Base-T Ethernet ports (with copper PHYs)
- ▶ Integrated NIC
 - ▶ Ethernet controller supporting an integrated NIC
- ▶ PCI to PCIe Bridge
 - ▶ Connects the Ethernet controller's PCI Express interface to the PCI interface of the CompactPCI backplane
- ▶ Magnetics
 - ▶ Five Ethernet transformers connected to the five front panel RJ45 connectors
- ▶ System Interfaces
 - ▶ Up to six Gigabit Ethernet ports
 - ▶ Five RJ45 connectors for category 5e (or better cabling)
 - ▶ One Gigabit Ethernet NIC port connected to Master CPU
- ▶ Monitor and Control
 - ▶ Five sets of integrated status LEDs for each RJ45 connector to monitor link/activity, and speed
 - ▶ Three on-board status LEDs to monitor the Gigabit Ethernet NIC link/activity, and speed
- ▶ CompactPCI Connector
 - ▶ 32-bit, female connector (J1)

2.2. Gigabit Ethernet Switch Controller

The Marvell 88E6352 Gigabit Ethernet switch controller provides the CP933 with up to six Ethernet ports, where five ports feature full-duplex 10/100/1000-triple speed Ethernet transceivers (copper PHYs) that are auto MDI/MDI-X capable.

The CP933's sixth port uses the Ethernet switch controller's SERDES digital interface, to connect to an Ethernet controller chip and act as an integrated NIC connecting to the master CPU of the CompactPCI system. The SERDES digital interface has one defined configuration speed (1000 Mbit/s) and therefore the CP933's sixth Ethernet port does not require auto-negotiation as only one speed is supported. Additionally, crossover MDI-X Ethernet signals are not required.

The Ethernet switch controller combines all the functions of a high-speed switch system, including high performance non-blocking Gigabit switch fabric with state-of-the-art features such as 1 Mbit frame buffer memory, jumbo frame support for up to 10 KBytes, and a high performance look-up engine with support for up to 8 K MAC addresses. Furthermore, the Ethernet Switch controller has fully integrated 10/100/1000Base-T Gigabit Ethernet transceiver (copper PHYs) meeting the requirements of IEEE 802.3, 802.3u, and 802.3ab standards and complying with the IEEE 802.3az Energy Efficient Ethernet (EEE) standards.

For further information on the Marvell 88E6352 Ethernet switch controller, refer to the Marvell 88E6352 data sheet.

2.3. Gigabit Ethernet Controller (Integrated NIC)

The Intel® I210-IS Ethernet controller acts as an integrated NIC by enabling the Ethernet switch controller's SERDES interface to connect to the master CPU over the Compact PCI backplane. The Ethernet Controller achieves this by connecting its PCI Express interface to a PCI to PCI Express bridge in reverse mode.

The SERDES has only one defined configuration speed of 1000 Mbit/s therefore; auto-negotiation is not required. Additionally, crossover MDI-X Ethernet signals are not required. The Ethernet controller's configuration data is stored within a separate flash memory.

2.4. PCI to PCI Express Bridge

In CompactPCI systems, a PCI interface connects to the CompactPCI backplane. The CP933 uses the Pericom PI7C9X111SL PCI to PCI Express reversible bridge featuring 3.3 V V(I/O) PCI signaling with 5 V V(I/O) tolerances, 32-bit PCI signaling, and up to 66 MHz PCI clock support. The PCI to PCI Express bridge operates in reverse mode connecting the Ethernet controller's PCI Express interface to the PCI interface of the CompactPCI backplane.

2.5. Ethernet Transformers (Magnetics)

The Ethernet switch controller receives Ethernet transmit and receive signals over five Ethernet transformers also known as magnetics that connect the five front panel RJ45 connectors to the Ethernet switch controller. The Ethernet transformers maintain consistent wave shape and suppression of common mode noise for data communication while providing equipment isolation in accordance with the IEEE 802.3 standard and are especially useful in industrial environments, where voltage potential differences between the different transmission stations can occur.

2.6. Front Panel Status LEDs

The five pairs of front panel status LEDs are controlled by the Ethernet switch controller, and integrated within the RJ45 connector. The front panel status LEDs display the network link/activity and speed of the connector's Ethernet port. The output polarity (ON/OFF) of the LED as well as blinking defines the network link/activity and speed.

Speed

The front panel RJ45 connector operates with 10/100/1000 triple speed Ethernet. To indicate the actual speed of the Ethernet connection the yellow status LED lights up to indicate 10 Mbit/s, the green status LED lights up to indicate 1000Mbit/s and both LEDs light up to indicate 100 Mbit/s.

Network Link and Activity

The LEDs blink to indicate an established network connection and network activity such as sent or received packets through the RJ45 connector. When the status LED does not blink, it means that there is no network activity. The yellow status LED blinks when a 10 Mbit/s network link is established and active. The green LED blinks when a 1000 Mbit/s network link is established and active. Both LEDs blink when a 100 Mbit/s network link is established and active.

Figure 5: Front Panel LED Activity



1. Definition of Status LED activity

On = Link
Blink = Active

Yellow status LED only

- ▶ ON 10 Mbit/s Link
- ▶ OFF No 10 Mbit/s Link
- ▶ Blinking Activity with 10 Mbit/s

Green status LED only

- ▶ ON 1000 Mbit/s Link
- ▶ OFF No 1000 Mbit/s Link
- ▶ Blinking Activity with 1000 Mbit/s

Both LED s

- ▶ Both ON 100 Mbit/s Link
- ▶ Both OFF No Link
- ▶ Both blinking Activity with 100 Mbit/s

2.7. On-board Status LEDs

The three on-board status LEDs display the network link/activity and speed of the sixth Ethernet NIC port. The Ethernet controller’s LED circuit output drivers control the on-board status LEDs. The output polarity (ON/OFF) as well as blinking shows the network link/activity and speed as described below

Figure 6: On-board status LEDs

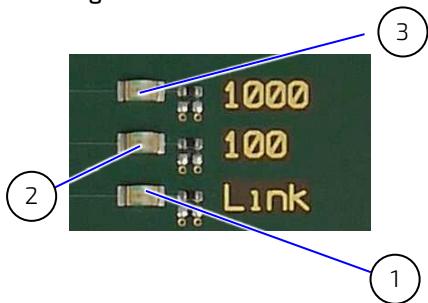

1. Link (green)

- ▶ ON Ethernet link active
- ▶ OFF No Ethernet link
- ▶ BLINKING Ethernet Activity

2. 100 Mbit/s (green)

- ▶ ON 100 Mbit/s (Used for test purposes only)

3. 1000 Mbit/s (green)

- ▶ ON 1000 Mbit/s

The Ethernet NIC uses the SERDES interface that specifies a speed of 1000 Mbit/s to connect to the Ethernet controller, therefore only the 1000 Mbits/s on-board status LED lights up. The 100 Mbit/s LED is included for test purposes only and under normal conditions will not light up



The SERDES interface specifies 1000 Mbit/s. Therefore, the Ethernet NIC port does not operate at 100 Mbit/s. If the 100 Mbit/s LED lights up this could indicate an error.

2.8. Board Interfaces

2.8.1. Front Panel Ethernet Interfaces

The front panel Ethernet wire-cabling interface uses 8-pin, female, RJ45 connectors for category 5e (or better) Ethernet cables for 10/100/1000Base-T Ethernet connections.

In total, the front panel provides five RJ45 connectors made up of a four-port RJ 45 connector (J6) and a one-port RJ45 connector (J7).

Figure 7: Gigabit Ethernet Connectors J6 and J7

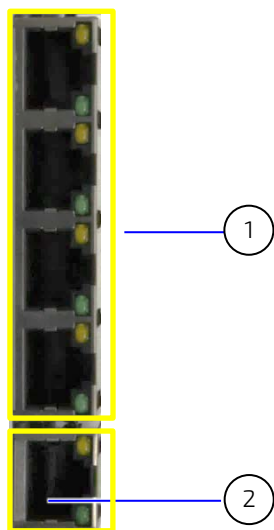

1. Four port, 8-pin, female RJ 45 connector (J6).
For Ethernet ports [1-4]
2. One port, 8-pin, female, RJ45 connector (J7).
For Ethernet port [5]

The interfaces provide automatic detection and switching between 10/100/1000Base-T data transmission, also known as auto-negotiation. Auto-wire switching for crossed cables (auto cross-over) is also supported.

Table 10 shows the signals from the front panel RJ45 connectors (J6 & J7), for the Media Dependent Interface (MDI) and Media Dependent Interface Crossed (MDIX) Ethernet standards with the appropriate Category 5e cabling for the implemented Ethernet standard.

Table 10: Front Panel RJ45 Connectors (J6 & J7) Pin Assignment for MDI/MDIX Standards

MDI - Standard Ethernet Cable						RJ45 Pin	MDIX - Crossed Ethernet Cable					
10Base-T		100Base-T		1000Base-T			10Base-T		100Base-T		1000Base-T	
I/O	Signal	I/O	Signal	I/O	Signal	I/O	Signal	I/O	Signal	I/O	Signal	
O	TX+	O	TX+	I/O	BA_DA+	1	I	RX+	I	RX+	I/O	BA_DB+
O	TX-	O	TX-	I/O	BA_DA-	2	I	RX-	I	RX-	I/O	BA_DB-
I	RX+	I	RX+	I/O	BI_DB+	3	O	TX+	O	TX+	I/O	BI_DA+
				I/O	BI_DC+	4					I/O	BI_DD+
				I/O	BI_DC-	5					I/O	BI_DD-
I	RX-	I	RX-	I/O	BI_DB-	6	O	TX-	O	TX-	I/O	BI_DA-
				I/O	BI_DD+	7					I/O	BI_DC+
				I/O	BI_DD-	8				RX+	I/O	BI_DC-

2.8.2. CompactPCI Connector (J1) Interface

The CompactPCI connector (J1), is a 2 mm x 2 mm pitch, 110-pin, female connector, supporting 32-bit PCI bus signals, arbitration, and 33 MHz or 66 MHz clock. Additionally, the CompactPCI connector (J1) provides power pins to supplying +3.3 V operating voltage with support for universal V(I/O) power pins for operation in CompactPCI systems with 3.3 V or 5 V (VI/O).

The CompactPCI connector (J1) is located at the rear of the CP933 board. For information on the CompactPCI connector (J1), pin layout and the pin assignment, see Table 11: CompactPCI Connector (J1).

Table 11: CompactPCI Connector (J1)

Pin	Row A	Row B	Row C	Row D	Row E	Row F	Compact PCI Connector J1	
25	NC	NC	NC	+ 3.3 V	NC	GND	 <p>25</p> <p>1</p> <p>F D B E C A</p> <p>Note: Pinrow F comprises GND pins.</p>	
24	AD(1)	NC	V(I/O)	AD(0)	NC	GND		
23	+ 3.3 V	AD(4)	AD(3)	NC	AD(2)	GND		
22	AD(7)	GND	+ 3.3 V	AD(6)	AD(5)	GND		
21	+ 3.3 V	AD(9)	AD(8)	M66EN	C/BE(0)#	GND		
20	AD(12)	GND	V(I/O)	AD(11)	AD(10)	GND		
19	+ 3.3 V	AD(15)	AD(14)	GND	AD(13)	GND		
18	SERR#	GND	3.3 V	PAR	C BE(1)#	GND		
17	+ 3.3 V	NC	IPMB	GND	PERR#	GND		
16	DEVSEL#	GND	V(I/O)	STOP#	LOCK#	GND		
15	+ 3.3 V	FRAME#	IRDY#	GND	TRDY#	GND		
12 to 14 (key area)								
11	AD(18)	AD(17)	AD(16)	GND	C/BE(2)#	GND		
10	AD(21)	GND	+ 3.3 V	AD(20)	AD(19)	GND		
9	C/BE(3)#	IDSEL	AD(23)	GND	AD(22)	GND		
8	AD(26)	GND	V(I/O)	AD(25)	AD(24)	GND		
7	AD(30)	AD(29)	AD(28)	GND	AD(27)	GND		
6	REQ#	GND	+ 3.3 V	CLK	AD(31)	GND		
5	BRSVP1A 5	BRSVP1B 5	RST#	GND	GNT#	GND		
4	IPMB_P WR	HEALTHY #	V(I/O)	NC	NC	GND		
3	INTA#	INTB#	NC	NC	NC	GND		
2	NC	MC	NC	TDO	TDI	GND		
1	NC	NC	TRSM#	NC	NC	GND		

Table 12: CompactPCI Connector (J1) Signal Description

PCI Pin	Description
#	Indicates that the signal is active at a low voltage.
(Without) #	Indicates that the signal is active at a high voltage
AD[31:0]	Multiplexed address/data lines
C/BE[3:0] #	Command and byte enable
CLK	33 MHz or 66 MHz CompactPCI clock
M66EN	Not used on CP933 because the PCI-to-PCIe bridge is in reverse mode.
DEVSEL#	Device select driven when accessed as CompactPCI slave
FRAME#	Cycle frame indicates beginning of a PCI transfer
IDSEL	Initialization Device select during configuration cycles
INTA#	Interrupt
IRDY#	Initiator ready indicates that bus master is ready to transmit/receive data
PAR	Parity over AD[31:0] and CBE[3:0]
PERR#	Parity error indicates data parity error during current bus cycle
RST#	Asynchronous reset
SERR#	System error
STOP#	Stop used by addressed slave to terminate the current bus cycle
TRDY#	Target ready indicates that selected device is ready for data transfer (read/write)
3.3 V	Main supply voltage for the CP933
V(I/O)	The PCI-to-PCIe bridge works with 3.3 V but has a 5 V tolerant PCI interface. Therefore, strapping pins are pulled high to V(I/O) instead of 3.3 V.

3/ Installation

The CP933 is designed for installation within a CompactPCI system rack where the CP933 is easily inserted into one of the CompactPCI backplane peripheral slots. However, the following standard precautions, installation procedures, and general information must be observed to ensure proper installation and to prevent damage to the board or injury to personnel.

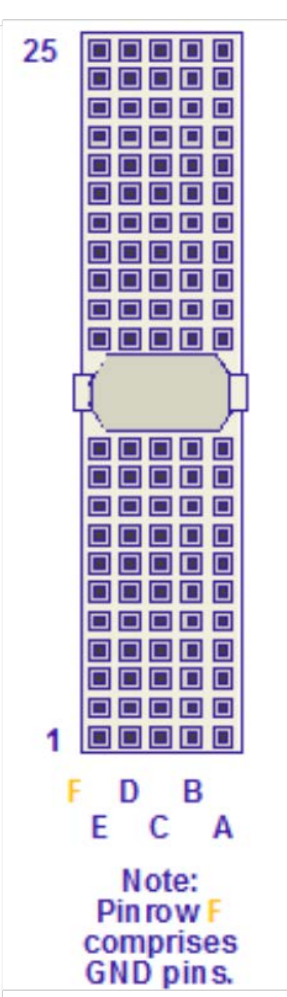
3.1. Hardware Installation

3.1.1. Safety Requirements

Before installing the CP933 in a CompactPCI backplane slot, read this installation chapter thoroughly for guidelines on positioning, installing and removing the board.

In addition, the following electrical hazard precautions must be observed.

⚠ CAUTION

Caution, Electric Shock Hazard!

Ensure that the system main power is removed prior to installing or removing this board. Ensure that there are no other external voltages or signals being applied to this board or other boards within the system. Failure to comply with the above could endanger life or health and cause damage to this board or other system components.



ESD Sensitive Device!

This CompactPCI board contains electrostatic sensitive devices. Observe the necessary precautions to avoid damage to your board:

- Discharge your clothing before touching the assembly.
- Discharge tools before use.
- Do not touch components, connector pins or traces.
- If working at an anti-static workbench, use the professional discharging equipment.

3.1.2. Location on the Backplane

It is possible to install the CP933 in any CompactPCI backplane slot except for the CompactPCI system's master slot. Consider the board's location within a system carefully. Factors such as the number of CompactPCI boards, their locations in a given system, and the operating system in use, may cause applications to have difficulty identifying boards properly. This includes board replacement, board movement to another slot, and other possible configuration changes to the initial system.

If the position of the board changes on the CompactPCI backplane, before putting the CompactPCI system into operation verify the proper operation of the system.



When configuring a system, install all boards in the system prior to installing drivers or other board related software. Failure to do so may result in the non-identification of a given board or boards.

3.1.3. Hot Swap Capabilities

The CP933 is not hot swappable. Read the following caution note carefully before installing or removing the CP933 from a CompactPCI backplane slot.

⚠ CAUTION

The CP933 CompactPCI board is not classified as hot swap capable, switch off the CompactPCI system power before installing the board in a free CompactPCI backplane slot. Failure to do so could result in personal injury and may damage your board or system.

3.1.4. Board Installation Procedures

Before installing the CP933 in a CompactPCI system rack, observe the safety information indicated in Chapter 3.1.1: Safety Requirements.

NOTICE

Failure to comply with the installation instructions below may cause damage to the board or other system boards and result in improper system operation. Read the following instructions carefully to correctly install the board in the system.

To install the CP933 CompactPCI board in a CompactPCI system rack proceed as follows:

1. Prior to installation of the board turn off all power to the CompactPCI system.
2. Disengage the insertion/extraction handle by first unlocking the handle and then pressing the handle down.

NOTICE

Do not forcibly push the board into the backplane connector. Instead, use the insertion/extraction handle to seat the board firmly in the backplane connector.

3. Insert the board into an appropriate slot, using the insertion/extraction handle to ensure that it is properly seated in the backplane.
4. The board is engaged when the insertion/extraction handle is locked and the front panel is flush with the rack front.
5. Fasten the two front panel retaining screws at the top and bottom of the front panel, to avoid loosening of the board through vibration and to provide an adequate earth connection.
6. Connect all external interfacing cables to the board as required.
7. Ensure that the interfacing cables are properly secured.
8. The board is now ready for operation.

3.1.5. Board Removal Procedures

Before removing the CP933 from a CompactPCI system rack, observe the safety information indicated in Chapter 3.1.1: Safety Requirements.

NOTICE

Failure to comply with the instruction instructions below may cause damage to the board or other system boards and result in improper system operation. Read the following instructions carefully to remove the CP933 CompactPCI board from the system.

To remove the CP933 CompactPCI board from a system rack proceed as follows:

1. Prior to removing the board turn off all power to the CompactPCI system.

NOTICE

Care must be taken when applying the procedures below to ensure that when the board is removed the board is not damaged through contact with other boards within the system.

2. Disconnect any interfacing cables connected to the board.
3. Loosen the front panel retaining screws.

4. Disengage the board from the backplane connector by unlock the insertion/extraction handle by pressing down, with a minimum of force on the locking mechanism in the middle of the handle and then carefully pressing the insertion/extraction handle until the board is disengaged.



If necessary lift the insertion/extraction handle up slightly while pressing down on the locking mechanism.

5. Pull the board out of the slot carefully, ensuring that the board does not make contact with adjacent boards on the CompactPCI backplane.



Do not use force! If the insertion/extraction handle does not move, then the board is not unlocked! Try to unlock the board again by repeating step 1 to step 5 of the board removal procedure.

6. When not in use store the board according to the Chapter 9.1: Storage within this user guide. Alternatively, dispose of the board in accordance with the laws and regulations within your region. For more information, see Chapter 10/ Disposal within this user guide.

3.1.6. Cabling

Up to five category 5e (or better) Ethernet cables for 10/100/1000Base-T Ethernet connections can be connected on the front panel.

3.2. Software Installation

The following CP933 Board Support Packages (BSP) with drivers are approved for Windows®, Linux and VXWorks®.

- ▶ Windows® - standard Intel® drivers
- ▶ Linux® - Linux Kernel with integrated drivers
- ▶ VxWorks® – standard Wind River®

For detailed Driver installation information, refer to the relevant CP933 driver documentation by visiting Kontron's product website.



Install all boards required for the application before installing the driver software. Failure to do so may result in the improper operation of the CompactPCI system.

4/ Configuration

The CP933 is designed for plug and play operation, and, as such, it does not have any user configurable board settings that are required for operation.

5/ Power Considerations

The CP933 has been designed for optimal power input and distribution. However, it is still necessary to observe certain criteria essential for application stability and reliability. When specifying the CP933's system environment, power specifications must be taken into account by system integrators.

5.1. System Power

The CP933 is powered by the CompactPCI backplane as specified in the CompactPCI specification (PICMG 2.0 Rev 3.0), and to power up, the CP933 must be connected to a CompactPCI backplane.



Power is supplied from the CompactPCI backplane only. The CP933 cannot be used as a standalone board.

5.2. Voltage Requirements

The CP933 uses a nominal supply voltage of +3.3 VDC from the CompactPCI backplane with a tolerance range of +5 %/-3% that must not be exceeded. If operated outside the specified voltage tolerance range, the CP933 is not guaranteed.

The CP933 features universal +3.3 V V(I/O) PCI signaling with a 5 V V(I/O) tolerance, enabling the CP933 to operate within a CompactPCI system with either +3.3 V or 5 V V(I/O) PCI signal voltages.

Table 13: Supply Voltage Specification

Voltage Type	Voltage Value	Tolerance
Supply Voltage	+3.3 VDC	+5 %/-3%
V(I/O) (PCI signaling voltage)	+3.3 VDC or 5 VDC	+5%/-3%
GND	Ground, not directly connected to protective earth (PE)	

CAUTION

The maximum permitted voltage must not be exceeded, failure to comply may result in damage to your board.

5.3. Backplane Requirements

The backplane must provide optimal power distribution for +3.3 VDC. It is recommended to use backplanes with a power plane for +3.3 VDC only. Input power connections to the backplane should be specified carefully to ensure a minimum of power loss and to guarantee operational stability. Long input lines, under dimensioned cabling or bridges, high resistance connections, and other possible aspects that could affect power distribution must be avoided.

5.4. Power Consumption

The typical theoretical maximum power consumption in Watts (W) is 4.5 W, at a nominal voltage of +3.3 VDC and under full load.



The power consumption is a calculated typical theoretical maximum and has not been measured or tested.

6/ Support

For technical support use one of the following three methods to contact Kontron's Support department.

▶ Web

For specific product support or downloads, more information can be found on Kontron's Support and Services website by entering a keyword, product or model number in the search field.

<https://www.kontron.com/support>

▶ Email

To request support, report documentation errors, or general customer feedback, use Kontron's Contact Support form.

<https://www.kontron.com/about-kontron/company-overview/contact-us/forms/contact-support>

If you do not get a response within 48 hours, end a follow up email to support@kontron.com.

▶ Phone

EMEA: +800-KONTRONAG or +49 821 4086 888

America: 800-480-0044

Make sure you have the following information available when you call and be ready to explain the nature of your problem to a member of the Support team.

- ▶ Product ID Number (PN),
- ▶ Serial Number (SN)



The serial number and product ID number can be found on the Type Label shown below, located on the top side of the CompactPCI connector (J1).

6.1. Product Identification and Type Label

The CP933 board can be identified by a type label positioned on the top side of the board on the CompactPCI connector. For more information on the location of the type label, see Figure 3: Board Layout – Top View.

Figure 8: Type Label

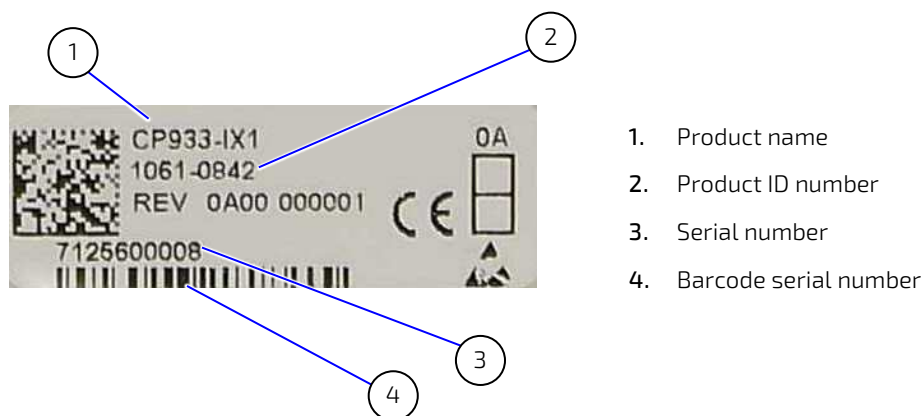

7/ Warranty

Kontron defines product warranty in accordance with regional warranty definitions. Claims are at Kontron's discretion and limited to the defect being of a material nature. To find out more about the warranty conditions and the defined warranty period for your region, following the steps below:

1. Visit Kontron's Term and Conditions webpage.
<http://www.kontron.com/terms-and-conditions>
2. Click on your region's General Terms and Conditions of Sale.

7.1. Limitation/Exemption from Warranty Obligation

In general, Kontron shall not be required to honor the warranty, even during the warranty period, and shall be exempted from the statutory accident liability obligations in the event of damage caused to the product due to failure to observe the following:

- ▶ General Safety Instructions for IT Equipment", information within this user guide
- ▶ Warning labels on the product and warning symbols within this user guide
- ▶ Information and hints within this user guide.

Additionally, the product must not be altered or modified in any way. Changes or modifications to the product that are not explicitly approved by Kontron, described in this user guide, or received from Kontron Support as a special handling instruction will void your warranty.

Due to their limited service life, parts that by their nature are subject to a particularly high degree of wear (wearing parts) are excluded from the warranty, beyond that provided by law.



If the product has been altered or modified in any way, the warranty is void.

8/ Returning a Defective Product

All goods returned to Kontron must have a Return of Material Authorization (RMA) number assigned exclusively by Kontron. Kontron cannot be held responsible for any loss or damage caused to the received product without an RMA number. The buyer accepts responsibility for all freight charges for the return of goods to Kontron's designated facility. Kontron will pay the return freight charges back to the buyer's location in the event that the product is repaired or replaced, within the stipulated warranty period.

To return any product to Kontron follow the steps below:

1. Visit the RMA Information website:
<http://www.kontron.com/support-and-services/support/rma-information>
2. Download the RMA Request sheet for your Kontron location and fill out the form. Take care to include a short detailed description of the observed problem or failure and to include product identification information such as product name, product ID number and serial number. If a delivery includes more than one product, fill out the above information in the RMA Request form for each product.
3. Send the completed RMA request form to the given fax or email address in the Contact and Delivery Address information for your Kontron location. Kontron then provides you with an RMA Number.
4. The product, to be returned for repair, must be packed properly for shipping, considering shock and ESD protection.



Goods returned to Kontron in non-proper packaging will be considered as customer caused faults and cannot be accepted as warranty repairs.

9/ Storage, Transportation, and Maintenance

9.1. Storage

Keep all the original packaging material for future storage or warranty shipments. If it is necessary to store the product then re-pack the product as originally delivered to avoid damage. The storage facility must meet the products environmental storage requirements as stated in Chapter 1.6.1: Environmental Specification.

9.2. Transportation

To ship the product use the original packaging, designed to withstand impact and adequately protect the product. When packing or unpacking products always take shock and ESD protection into consideration and use an EOS/ESD safe working area.

9.3. Maintenance

Before performing any maintenance, read the relevant safety instruction within this user guide. See Chapter 3.1.1: Safety Requirements before removing the board from the CompactPCI system rack.

CAUTION

Before performing any maintenance, the CP933 should be disconnected from the power source by removing the CP933 from the CompactPCI backplane.

NOTICE

When removing the CP933 from the CompactPCI backplane, care must be taken to ensure that the CP933 is not damaged through contact with other boards on the CompactPCI backplane.

9.3.1. Preventative Maintenance

To avoid possible cleaning maintenance of the board, care should be taken to ensure that the CP933 is used in a dust free environment, within a CompactPCI rack including air filters to reduce dust and dirt particle to a minimum. Cleaning of the CP933 could damage components.

If the CP933 is used in dust-prone environment. To protect the CP933 from dust, an air filter must be considered, within the CompactPCI rack.

NOTICE

When used in a dust-prone environment, an air filter must be considered within CompactPCI rack.

10/ Disposal

Final disposal of this product after the product's service life must be accomplished in accordance with the applicable country, state, or local laws or regulations.



Kontron manufactures products to satisfy environmental protection requirements where possible. Many of the components used are capable of being recycled.

Kontron follows the Waste Electrical and Electronic Equipment (WEEE) Directive that aims to reduce waste arising from Electrical and Electronic waste and therefore encourages customers to return Kontron products for proper disposal. For more information regarding WEEE compliance, see the Disposal and Recycling section at the start of this user guide.

Appendix A: List of Acronyms

Table 14: List of Acronyms

BSP	Board Support Package
cPCI	Compact Peripheral Component Interconnect
CPU	Central Processing Unit
ECT	Embedded Computing Technology
EEE	Electrical and Electronic Equipment
IEEE	Institute of Electrical and Electronics Engineers
IOT	Internet of Things
LAN	Local Area Network
LED	Light Emitting Diode
N/A	Not Applicable
NC	Not Connected
NIC	Network Interface Controller
MAC	Media Access Controller
MDI	Media Dependent Interface

MDIX	Media Dependent Interface crossed
MII	Media Independent Interface
PCI	Peripheral Component Interconnect
PCIe	Peripheral Component Interconnect Express
PICMG®	PCI Industrial Computer Manufacturers Group
PHY	Physical layer
PE	Protective Earth
PN	Product Number
RMA	Return of Material Authorization
RTC	Real Time Clock
SERDES	Serializer-Deserializer
SN	Serial Number
SOL	Serial Over LAN
WEEE	Waste Electrical and Electronic Equipment



About Kontron

Kontron is a global leader in embedded computing technology (ECT). As a part of technology group S&T, Kontron offers a combined portfolio of secure hardware, middleware and services for Internet of Things (IoT) and Industry 4.0 applications. With its standard products and tailor-made solutions based on highly reliable state-of-the-art embedded technologies, Kontron provides secure and innovative applications for a variety of industries. As a result, customers benefit from accelerated time-to-market, reduced total cost of ownership, product longevity and the best fully integrated applications overall. For more information, please visit: www.kontron.com.



Global Headquarters

Kontron S&T AG

Lise-Meitner-Str. 3-5
86156 Augsburg
Germany
Tel.: + 49 821 4086-0
Fax: + 49 821 4086-111
info@kontron.com